

## Integrated Motor Drive Controllers

PT, PR & PS-Series

Catalog  
IMDC01EN



[www.electrocrafter.com](http://www.electrocrafter.com)



For over 60 years, ElectroCraft has been helping engineers translate innovative ideas into reality – one reliable solution at a time. As a global specialist in custom motor and motion technology, we provide the engineering capabilities and worldwide resources you need to succeed.

# Table of Contents

## Integrated Motor Drive Controllers

Advantages of Integrated Motor Drive Controllers . . . . 3  
 About Integrated Motor Drive Controllers . . . . . 5  
 Drive Features . . . . . 6  
 Electrical Specifications . . . . . 7  
 MotionPRO Software . . . . . 8



Product Range . . . . . 21  
 Part Number Configurator . . . . . 23  
 Accessories . . . . . 24

This guide has been developed as a quick reference tool for ElectroCraft products. It is not intended to replace technical documentation or proper use of standards and codes in installation of product.

Because of the variety of uses for the products described in this publication, those responsible for the application and use of this product must satisfy themselves that all necessary steps have been taken to ensure that each application and use meets all performance and safety requirements, including all applicable laws, regulations, codes and standards.

Reproduction of the contents of this copyrighted publication, in whole or in part without written permission of ElectroCraft is prohibited.

Designed by stilbruch.me

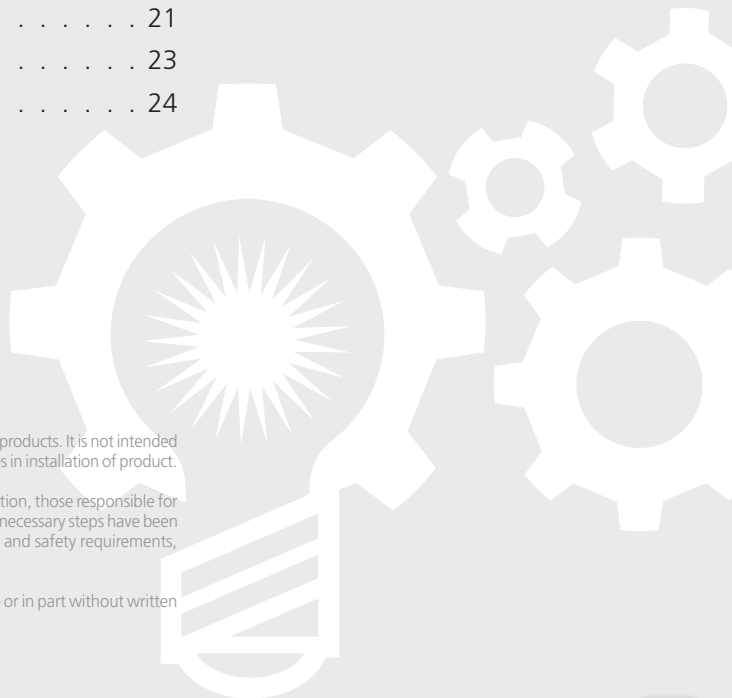

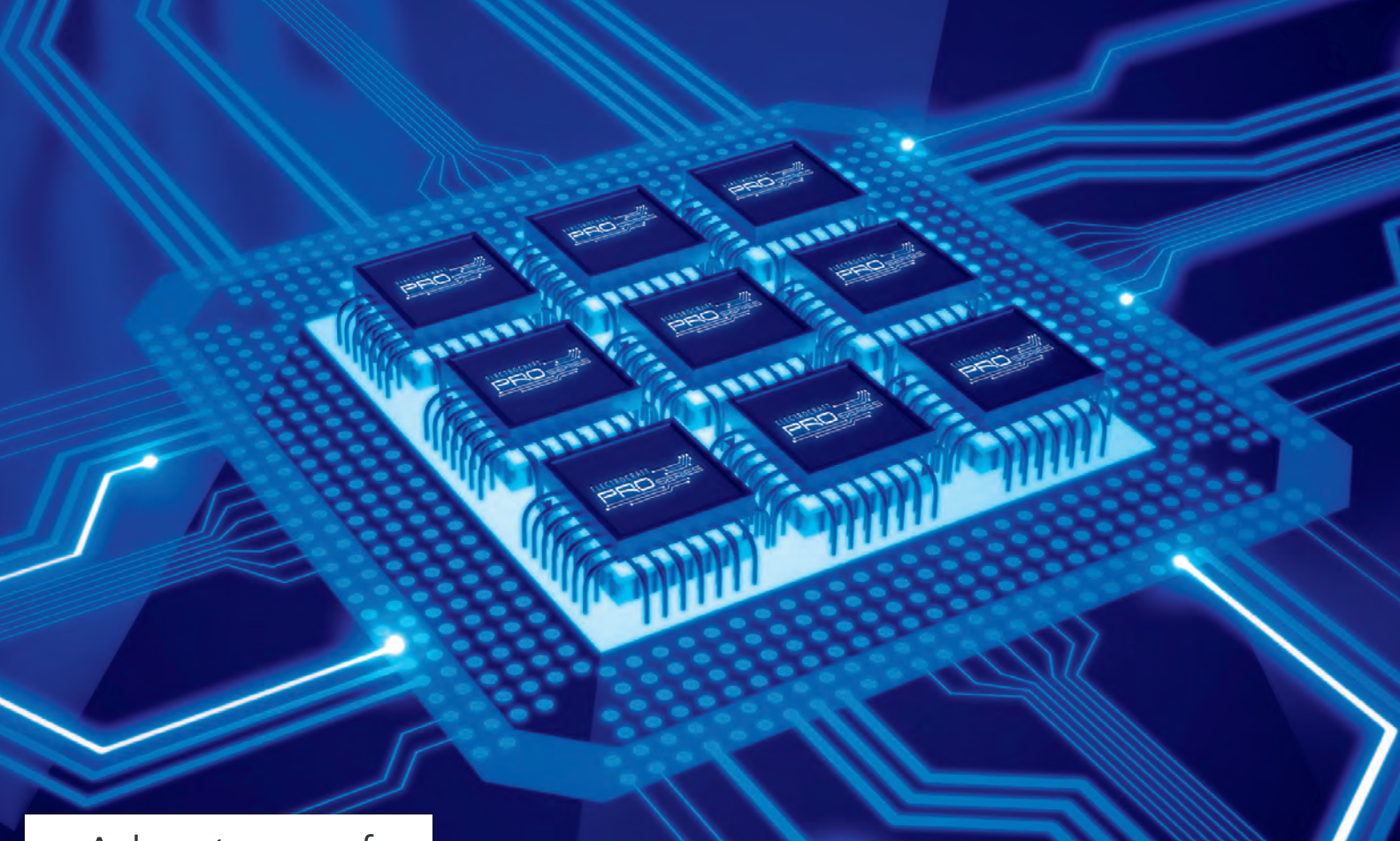

## Advantages of

# Integrated Motor Drive Controllers



ElectroCraft PRO Series Integrated Motor Drive Controllers (IMDC) combine our most advanced motor, drive and control technologies into a single package to provide a new level of motion control capability.

The motor types have been selected for their compact size, high performance characteristics and rugged, field-proven capabilities. The integrated drive is based on ElectroCraft's successful PRO Series programmable servo drive. Together, each combination offers a level of functional precision that has never previously been available in a single package.

### **The Range.**

The PRO Series IMDC range includes brushless motor variants, stepper motor variants and linear actuators. Each is ruggedly designed to withstand industrial environments and incorporates a high performance servo drive incorporating our PRO Series advanced control and sequencing functionality. Each ultra-compact package includes high-performance closed-loop control, a fully-programmable digital sequence engine, fully-configurable analog and digital I/O and deterministic real-time communications. These enable each IMDC to serve as either a stand-alone control solution or as part of a fully-integrated multi-axis system.

### **The Advantages.**

Combining motor, drive and controller in a single package offers the potential to revolutionize machinery design.

### **Use ElectroCraft's PRO Series IMDC range to**

- reduce build time. Fewer components mean less man hours.
- reduce cabling complexity and cost.
- simplify build. Smaller inventory and fewer operations needed to install.
- reduce installation time.
- reduce machine footprint. No need for a centralized control cabinet.
- reduce total installation cost.



### **Using the PRO Series IMDC range will also**

- improve product quality. Each drive is fully-optimized to suit each motor and the embedded tuning capability optimizes loop stability.
- optimize energy efficiency. Energy losses through cabling are reduced and each motor can be individually tuned to match the characteristics of its load.
- reduce EMC issues.
- reduce operation costs.

### **Highly advanced functions.**

The PRO Series IMDC's advanced functionality means that you can address complex system control applications. The drive's open architecture means that all system variables are accessible to the designer, so data analysis and high-level diagnostics can be easily implemented.

ElectroCraft PRO Series

## Integrated Motor Drive Controllers



High performance variable-speed motors with fully-integrated drives and motion controllers. Rated input voltage 12-48V.

Available in three motor types:

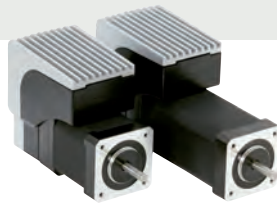

### ElectroCraft

#### PT Stepper IMDC.

- Intelligent stepper motor with fully-integrated drive, motion controller and optional position feedback.
- Available in two sizes, 42 mm and 56 mm (comparable to NEMA17 and 23) and up to three motor lengths.
- From 0.44 Nm – 1.7 Nm (62 oz-in – 241 oz-in) of holding torque available.
- Separate power and logic supplies.
- Open-loop or closed-loop operation.
- 5 dedicated and programmable digital inputs, 1 analog input.
- 2 programmable outputs.
- Internal EEPROM for data and motion program storage.
- RS232 or CAN/CANopen communication bus.

### ElectroCraft

#### PR Brushless DC IMDC.

- Intelligent brushless servo motor drive with fully-integrated, motion controller and position feedback.
- Available in two sizes, 42 mm and 60 mm (comparable to NEMA17 and 23) and four motor lengths.
- 0.08 Nm – 0.52 Nm (12 oz-in – 73.6 oz-in) of continuous torque available, at speeds up to 10,000 rpm.
- Separate power and logic supplies.
- 5 dedicated and programmable digital inputs, 1 analog input
- 2 programmable outputs.
- Internal EEPROM for data and motion program storage.
- RS232 or CAN/CANopen communication bus.

### ElectroCraft

#### PS Stepper Actuator IMDC.

- Intelligent linear actuators with fully-integrated drive, motion controller and optional position feedback.
- Available in two sizes, 42 mm and 56 mm (comparable to NEMA17 and 23) and two motor lengths.
- Up to 800 N (180lb) of holding force.
- Speeds up to 174 mm/sec (6.8 in/sec).
- Separate power and logic supplies.
- Open-loop or closed-loop operation.
- 5 dedicated and programmable digital inputs, 1 analog input.
- 2 programmable outputs.
- Internal EEPROM for data and motion program storage.
- RS232 or CAN/CANopen communication bus.

## ElectroCraft PRO Series Integrated Motor Drive Controllers

### Drive and Control Features

- Various modes of operation including torque, speed or position control, position or speed profiles, external analog reference or commands sent via communication bus.
- Comprehensive motion instruction set for the definition and execution of motion sequences.
- CAN 2.0B up to 1Mbits/s (CANopen (CiA 301v4.2 and 402v3.0) protocols).
- Single power supply 12 – 36V, dual supply 36 – 48V.
- Logic supply optional 9 – 36V.
- 7 digital I/O (5 inputs and 2 outputs) and 1 analog input.
- Standalone operation with stored motion sequences.
- RS-232 serial communication.
- Switching frequency up to 100kHz.
- Hardware protections; short-circuit, over-voltage, under-voltage and I<sup>2</sup>T.

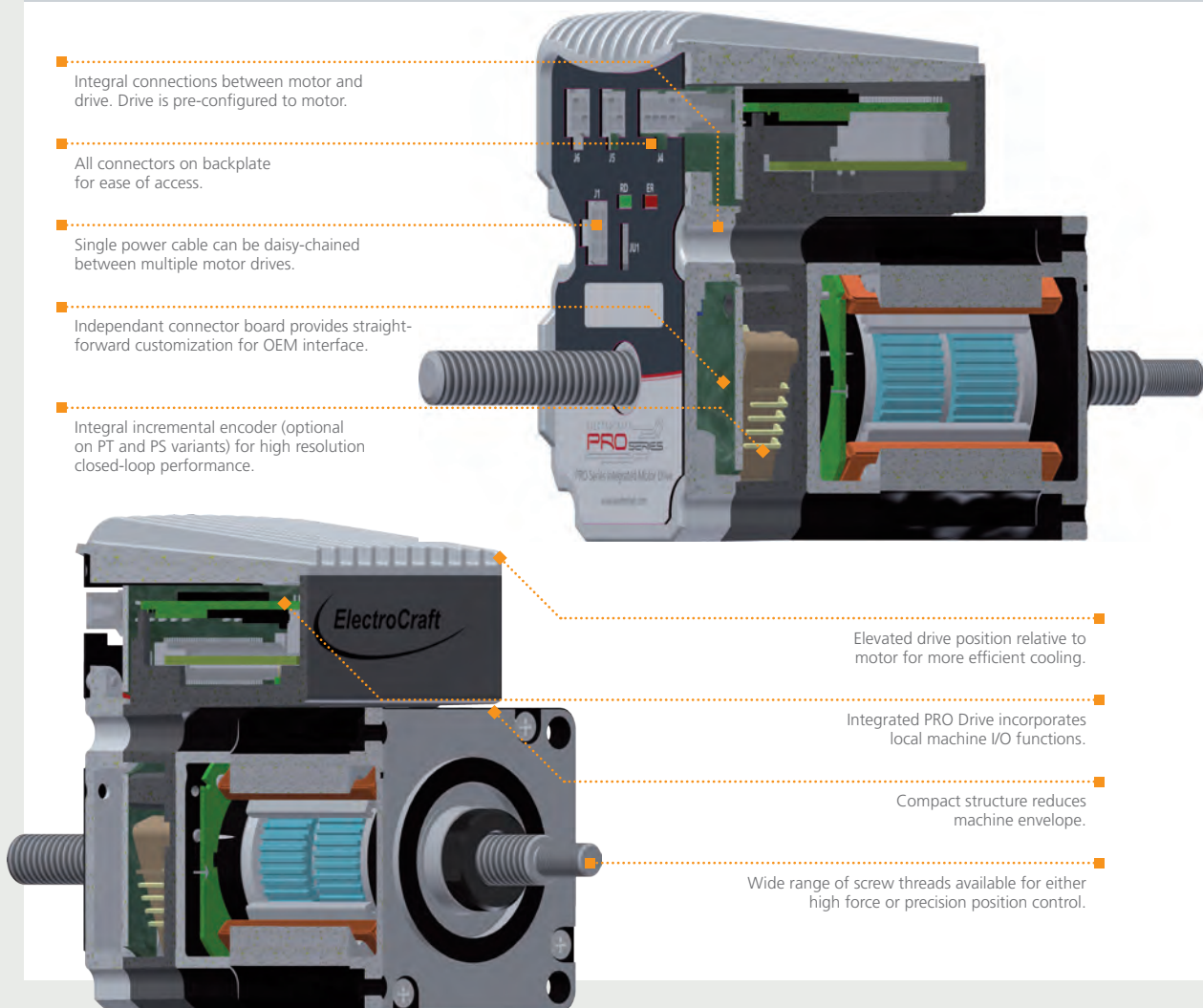

## Integrated Motor Drive Controller

# Electrical Specifications

Conditions					
Operating		Min	Typ	Max	Units
Ambient Temperature		0		+40	°C
Ambient Humidity	Non-condensing	0		90	% Rh
Altitude/Pressure	Altitude (vs. sea level)	-0.1	0 – 2.5	*	km
	Ambient Pressure	0	0.75 – 1	10.0	atm
Storage		Min	Typ	Max	Units
Ambient Temperature		-40		+100	°C
Ambient Humidity	Non-condensing	0		100	% Rh
Ambient Pressure		0		10.0	atm

\* IMDCs can be operated in vacuum (no altitude restriction), but at altitudes over 2,500 m, current and power rating are reduced due to thermal dissipation efficiency.

Electrical Specifications			
Maximum DC supply voltage	Motor	48	Volt
	Logic	36	Volt
Nominal switching frequency		20 – 60	kHz

Input					
Logic Supply input (+V <sub>LOG</sub> )		Min	Typ	Max	Units
Supply Voltage	Nominal values	9		36	V <sub>DC</sub>
	Absolute maximum values, drive operating but outside guaranteed parameters	8		39	V <sub>DC</sub>
	Absolute maximum values, continuous	-0.6		42	V <sub>DC</sub>
	Absolute maximum values, surge (duration ≤10 ms)	-1		+45	V <sub>DC</sub>
Supply Current – No Load on Digital Outputs	+V <sub>LOG</sub> = 9 V		190	320	mA
	+V <sub>LOG</sub> = 12 V		145	220	
	+V <sub>LOG</sub> = 24 V		100	150	
	+V <sub>LOG</sub> = 40 V		70	125	
Motor supply input (+V <sub>MOT</sub> )		Min	Typ	Max	Units
Supply Voltage	Nominal values	11		50	V <sub>DC</sub>
	Absolute maximum values, drive operating but outside guaranteed parameters	9		52	V <sub>DC</sub>
	Absolute maximum values, continuous	-0.6		54	V <sub>DC</sub>
	Absolute maximum values, surge (duration ≤10 ms)	-1		+57	V <sub>DC</sub>
Supply Current	Idle		1	5	mA
	Operating	-20	±8	+20	A
	Absolute maximum value, short-circuit condition (duration ≤10 ms)			26	A

Protection					
Motor Outputs (A/A+, B/A-, C/B+, BR/B-)		Min	Typ	Max	Units
Short-circuit protection threshold	Measurement range		±26	±30	A
Short-circuit protection delay		5	10		µsec



ElectroCraft

# MotionPRO Software



ElectroCraft's PRO Series Integrated Motor Drive Controllers are supplied with MotionPRO drive configuration software. This is a menu-driven configuration tool that enables the user to set up all motor, drive, I/O, communication and sequencing functions from a single interface.

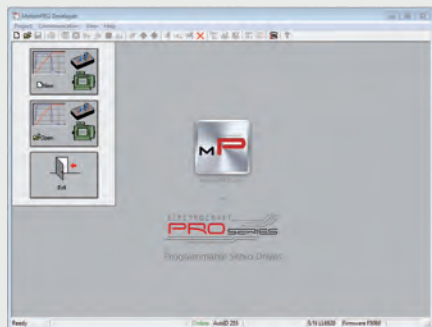

The software has been designed for ease of use. All parameters can be accessed via a series of menus from a single set-up screen. Simply click on the appropriate icon to open the menu for the function you want to configure.



Motion profiles can be programmed online or offline. Operators can

create their own program or upload a program from a library or an existing installation which can then be modified if desired.

Once the system has been configured, the program can be stored for download into other products for quick and easy set-up of multiple installations.

ElectroCraft's MotionPRO drive configuration software incorporates a number of diagnostic tools to enable the operator to quickly optimize the performance of the system. This includes real-time oscilloscope display, I/O status indicators and dynamic parameter monitors. The products' open-architecture structure enables any operating parameter to be monitored.

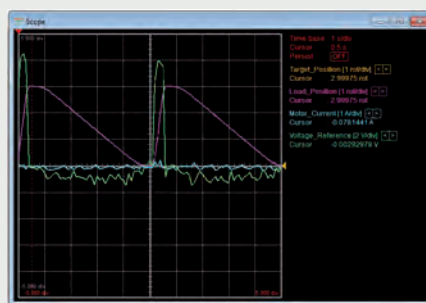

The motion-configuration tool incorporates standard motion functions, such as S-curves, as well as a fully-programmable sequence engine and a library of mathematical functions to allow the operator to calculate complex motion sequences.

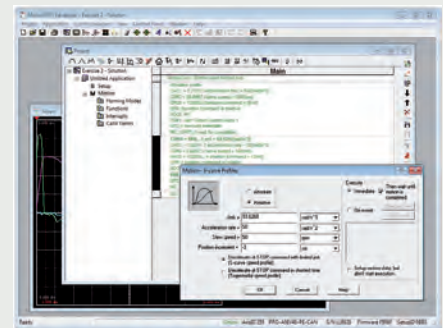

The Motion Sequencer is linked directly to the analog and digital I/O ports. I/O functionality is assigned by software and the MotionPRO conditional logic enables any I/O port to be assigned to any parameter, allowing the motor drive to operate as a self-contained system controller.

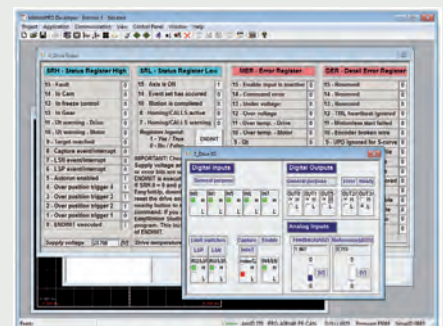

Whether you want your IMDC to serve as a stand-alone motion controller, or as part of a multiple axis distributed array, ElectroCraft's MotionPRO configuration software has the flexibility to enable you to set up your system quickly and easily.

# ElectroCraft PRO Series Integrated Motor Drive Controller

## PT42: Stepper IMDC



The PT42 combines the ElectroCraft TorquePower™ Enhanced high-performance stepper motor with the advanced functionality of the Integrated PRO Series Drive. The motor can be driven in open-loop stepper mode or in closed-loop using the integrated encoder and offers high holding torque and high accuracy in a robust, compact package. Two frame lengths are available in this size, offering holding torque of up to 55 Ncm (78 oz.in).

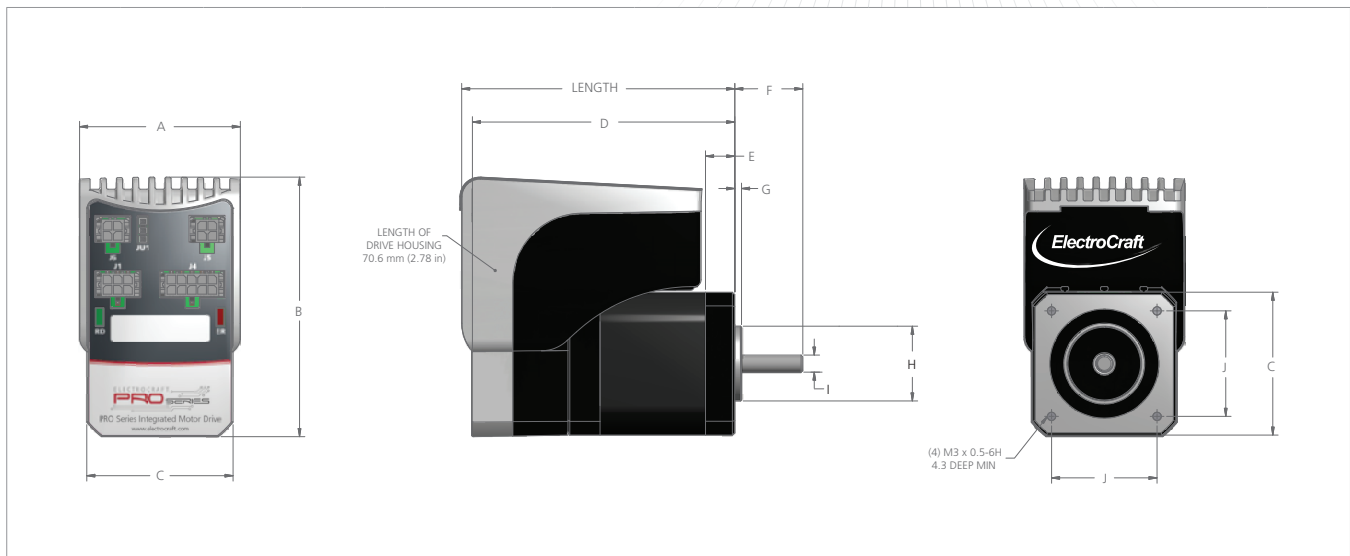
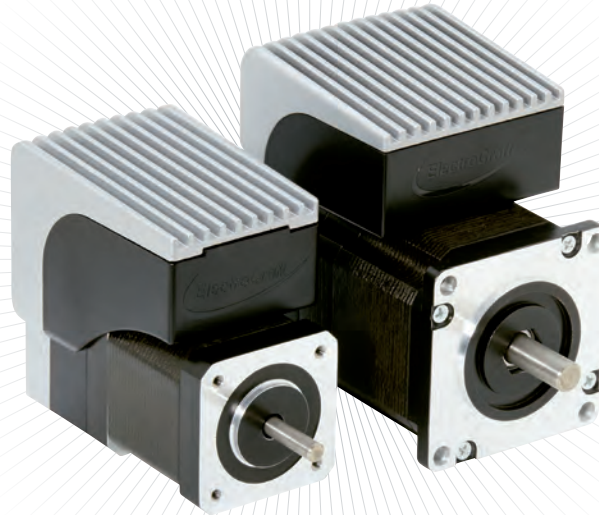

Model	Units	Length	A	B	C	D	E	F	G	H	I	J
PT42-A44	mm	72.27	47.24	76.3	42.96	69.32	8.6	20±0.76	2.0	21.97-22.0	4.99-5.0	31.0
	inch	2.85	1.86	3.0	1.69	2.73	0.34	0.79±0.03	0.08	0.8648-0.866	0.1963-0.1967	1.22
PT42-A55	mm	80.27	47.24	76.3	42.96	77.12	8.6	20±0.76	2.0	21.97-22.0	4.99-5.0	31.0
	inch	3.16	1.86	3.0	1.69	3.04	0.34	0.79±0.03	0.08	0.8648-0.866	0.1963-0.1967	1.22

Available with ¼" shaft. See page 26 for NEMA sizes.

## Parameter

Motor designation	PT42-A44	PT42-A55	Motor designation	PT42-A44	PT42-A55
Rated input voltage VDC	12 – 48		Step Angle %/Step	1.8	
Frame length mm (in)	72 (2.85)	80 (3.16)	Rotor Inertia Motor Rated Current, A 2.8 Kg.cm <sup>2</sup> (oz-in sec <sup>2</sup> )	0.062 (0.00086)	0.083 (0.0012)
Holding Torque Ncm (oz-in)	44 (62)	55 (78)	Phase Resistance Ohm	1.25	1.58
Weight* Kg (oz)	0.47 (16.6)	0.54 (19)	Phase Inductance mH	2.32	3.4

\*Typical weight. May vary with options selected.

Rated operating temperature 40°C

## Torque/speed curves

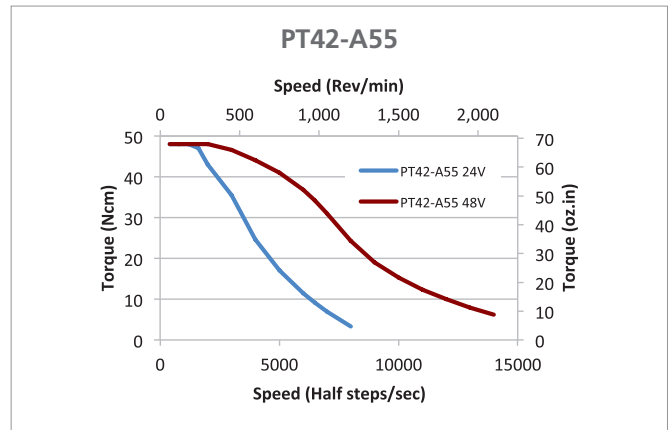
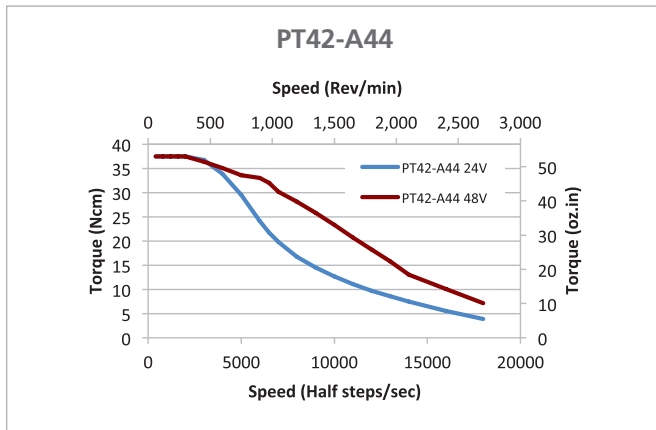

Order part code for the PT42-A44V48A-0-D-CAN

PT	42	-	A	44	V	48	-	0	D	CAN	See fold-out in back of brochure for more information.
Motor technology	Frame size		Drive type	Holding torque	Voltage	Front Shaft	Feedback	Network			

# Customize your options ...

For the past 60 years, the global team at ElectroCraft has helped engineers like you translate innovative ideas into reality.

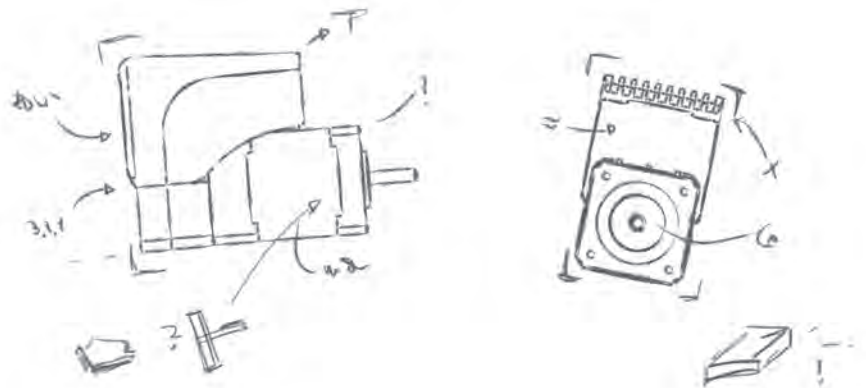

# ElectroCraft PRO Series Integrated Motor Drive Controller

## PT56: Stepper IMDC



The PT56 combines the ElectroCraft TorquePower™ Plus hybrid stepper motor with the advanced functionality of the Integrated PRO Series Drive. The motor can be driven in open-loop stepper mode or in closed-loop using the integrated encoder and offers high holding torque and high accuracy in a robust, compact package. Three frame lengths are available in this size, offering holding torque of up to 170 Ncm (241 oz-in).

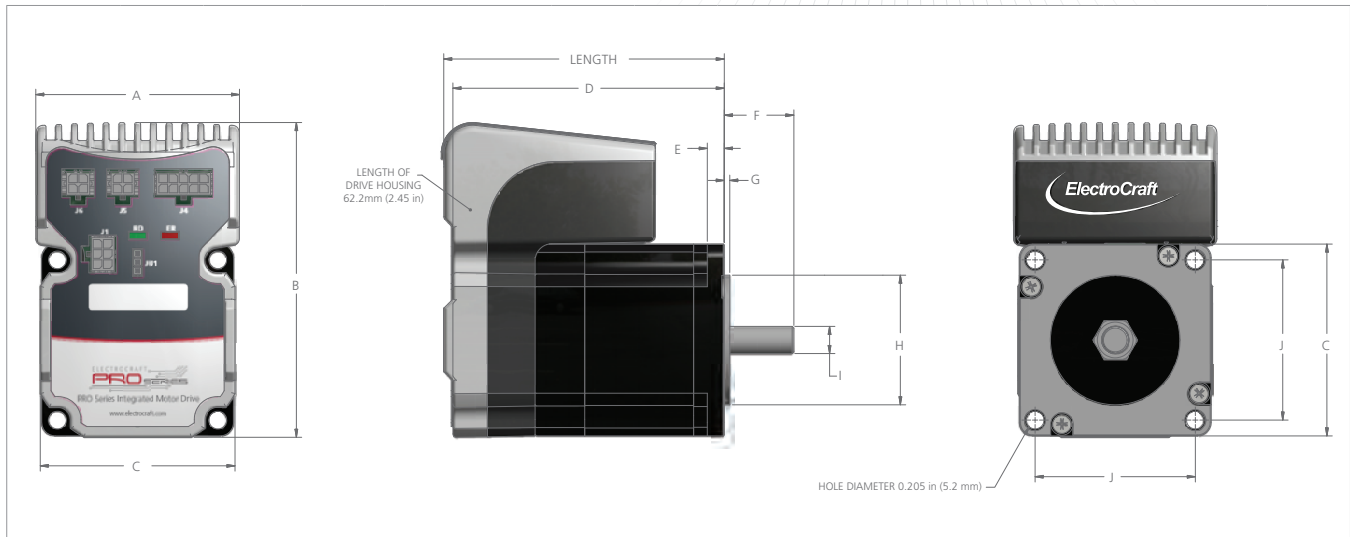

Model	Units	Length	A	B	C	D	E	F	G	H	I	J
PT56-A64	mm	70.94	59.86	92.51	57.21	68.25	5	20.45±0.76	1.6	38.1±0.05	7.98-7.99	47.1
	inch	2.79	2.36	3.64	2.25	2.69	0.2	0.81±0.03	0.063	1.5±0.002	0.314-0.3145	1.85
PT56-A106	mm	82.44	59.86	92.51	57.21	79.75	5	20.45±0.76	1.6	38.1±0.05	7.98-7.99	47.1
	inch	3.25	2.36	3.64	2.25	3.14	0.2	0.81±0.03	0.063	1.5±0.002	0.314-0.3145	1.85
PT56-A170	mm	104.94	59.86	92.51	57.21	102.25	5	20.45±0.76	1.6	38.1±0.05	7.98-7.99	47.1
	inch	4.13	2.36	3.64	2.25	4.03	0.2	0.81±0.03	0.063	1.5±0.002	0.314-0.3145	1.85

Available with ¼" shaft. See page 26 for NEMA sizes.

## Parameter

Motor designation	PT56-A64	PT56-A106	PT56-A170	Motor designation	PT56-A64	PT56-A106	PT56-A170
Rated Input Voltage VDC	12 – 48			Rotor Inertia Kg.cm <sup>2</sup> (oz-in sec <sup>2</sup> )	0.141 (0.00198)	0.248 (0.0035)	0.430 (0.0061)
Frame length mm (in)	71 (2.79)	82 (3.25)	105 (4.13)	Motor Rated Current A	4.2		
Holding Torque Ncm (oz-in)	64 (91)	106 (150)	170 (241)	Phase Resistance Ohm	0.6	0.8	1.0
Step Angle °/step	1.8			Phase Inductance mH	2.0	3.5	4.8
*Weight Kg (oz)	0.7 (24)	0.9 (31)	1.24 (44)	*Typical weight. May vary with options selected. Rated operating temperature 40°C			

## Torque/speed curves

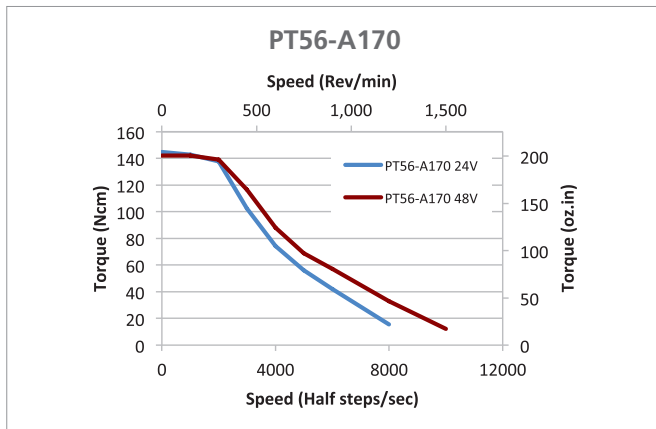
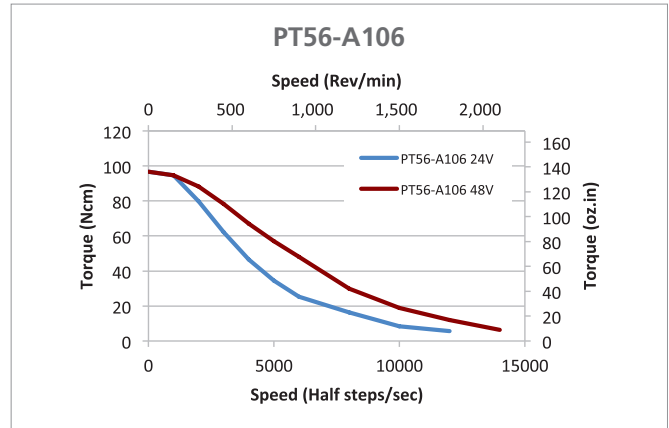
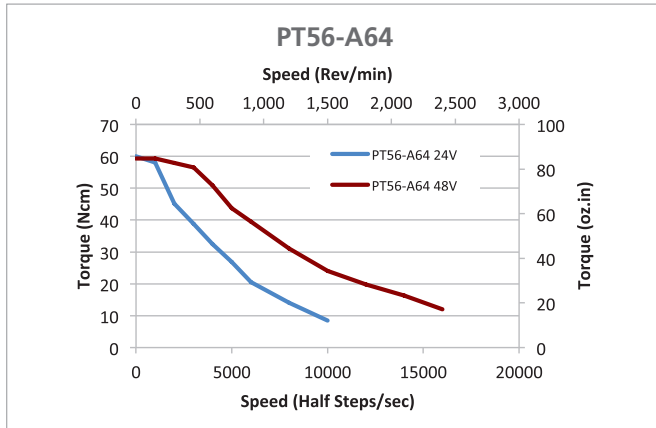

Order part code for the PT56-A170V48A-0-D-CAN

PT	56	-	A	170	V	48	-	0	D	CAN	See fold-out in back of brochure for more information.
Motor technology	Frame size		Drive type	Holding torque		Voltage		Front Shaft	Feedback	Network	

# ElectroCraft PRO Series Integrated Motor Drive Controller

## PR42: Brushless DC IMDC



The ElectroCraft PR42 integrated brushless DC motor drive controllers are designed for high-precision applications. Each combines a high-performance neodymium brushless motor with a fully-programmable PRO Series controller, providing a high level of control accuracy in a very compact package. Four frame lengths are available in this PR42 variant, providing peak torque of up to 96 Ncm (136oz-in) and speeds of up to 11,400RPM.

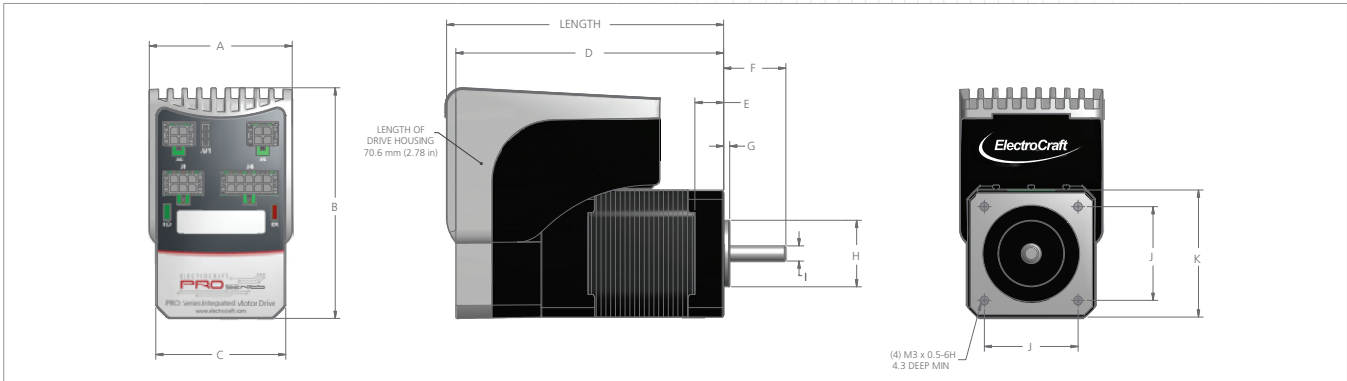
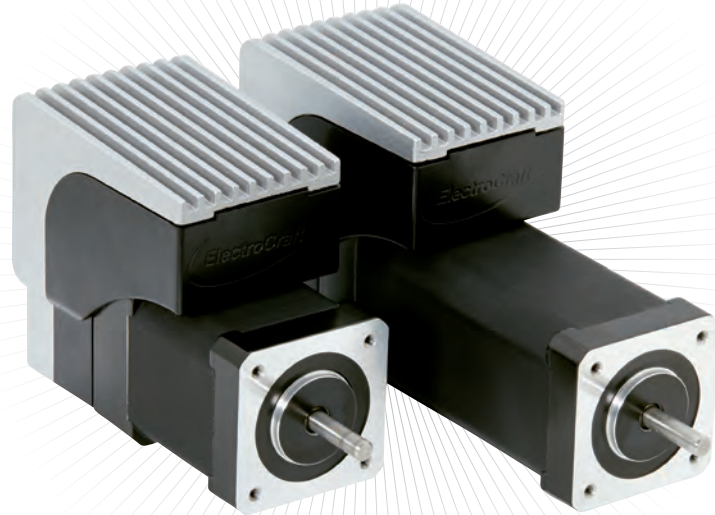

Model	Units	Length	A	B	C	D	E	F	G	H	I	J	K
PR42-A8	mm	71	47.24	76.3	42.96	67.8	9.5	20.59±0.76	2.01	21.97 - 22	4.99 - 5	30.99	42
	inch	2.8	1.86	3.0	1.69	2.7	0.37	0.81±0.03	0.08	0.8648-0.866	0.1963 - 0.1967	1.22	1.65
PR42-A16	mm	91.6	47.24	76.3	42.96	88.52	9.5	20.59±0.76	2.01	21.97 - 22	4.99 - 5	30.99	42
	inch	3.6	1.86	3.0	1.69	3.48	0.37	0.81±0.03	0.08	0.8648-0.866	0.1963 - 0.1967	1.22	1.65
PR42-A25	mm	109	47.24	76.3	42.96	105.9	9.5	20.59±0.76	2.01	21.97-22	4.99 - 5	30.99	42
	inch	4.3	1.86	3.0	1.69	4.17	0.37	0.81±0.03	0.08	0.8648-0.866	0.1963 - 0.1967	1.22	1.65
PR42-A32	mm	131.1	47.24	76.3	42.96	128.52	9.5	20.59±0.76	2.01	21.97-22	4.99 - 5	30.99	42
	inch	5.2	1.86	3.0	1.69	5.06	0.37	0.81±0.03	0.08	0.8648-0.866	0.1963 - 0.1967	1.22	1.65

## Parameter

Motor designation	PR42-A8	PR42-A16	PR42-A25	PR42-A32	Motor designation	PR42-A8	PR42-A16	PR42-A25	PR42-A32
Rated input voltage VDC	12 – 48				Rotor Inertia Kg.cm <sup>2</sup> (oz-in sec <sup>2</sup> )	0.0565 (0.0008)	0.083 (0.00117)	0.113 (0.0016)	0.134 (0.0019)
Frame length mm (in)	71 (2.8)	91.6 (3.6)	109 (4.3)	131.1 (5.2)	No Load Speed Rev/min	11,400	10,450	6,800	4,910
Encoder lines/rev	1000, 2000, 5000				Phase Resistance Ohm	2.5	1.07	1.3	1.95
Continuous Torque Ncm (oz-in)	8 (12)	16 (22.7)	25 (36)	32 (45.5)	Phase Inductance mH	2.0	1.2	1.4	2.3
Peak Torque Ncm (oz-in)	32 (45)	42 (60)	71 (100)	96 (136)	Torque Constant Ncm/A (oz-in/A)	4.0	4.3	6.8	8.8
*Motor weight Kg (oz)	0.35 (12.5)	0.57 (20.1)	0.77 (27)	0.95 (33.5)	Voltage Constant V/kRPM	4.2	4.5	7.1	9.2

\*Typical weight. May vary with options selected.

Rated operating temperature 40°C

## Torque/speed curves

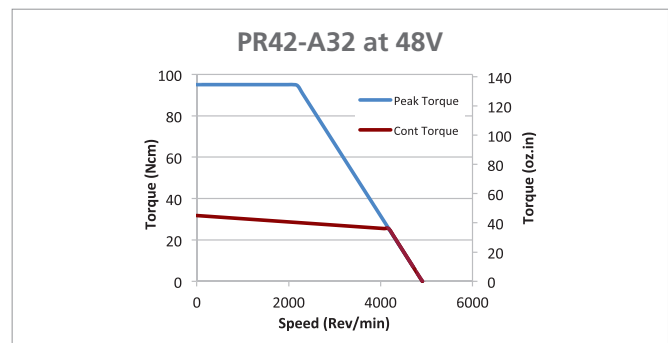
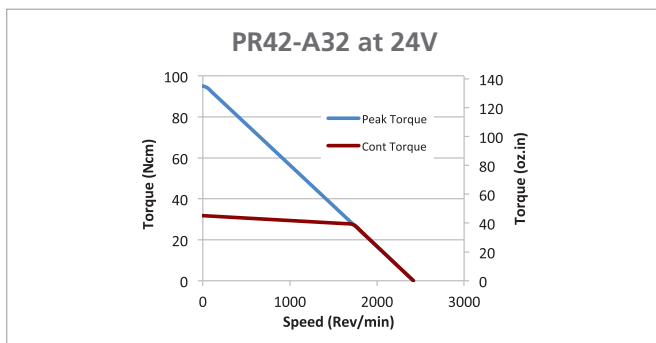
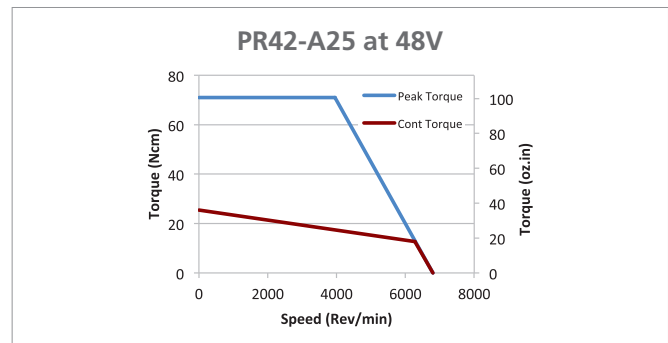
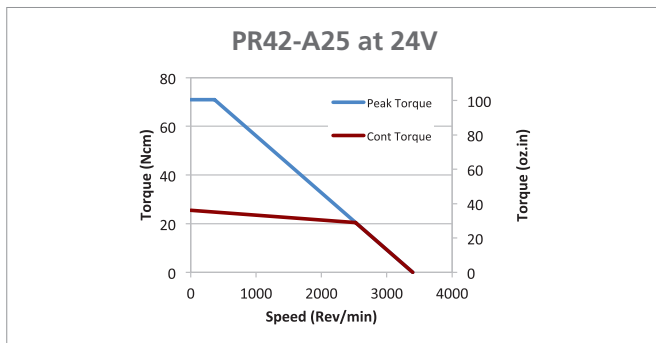
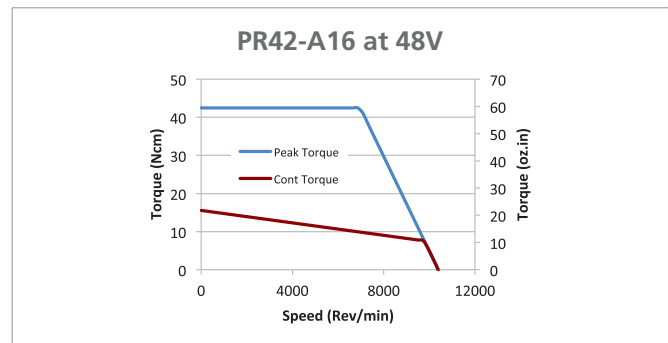
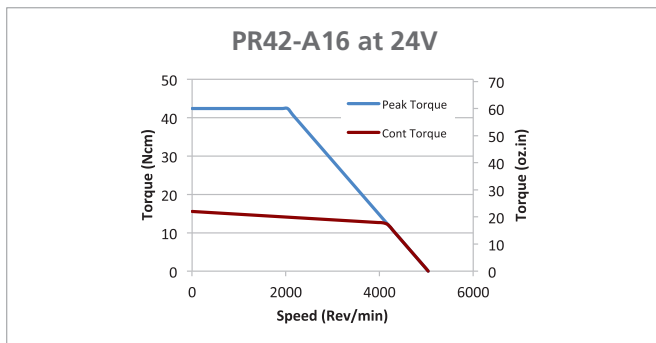
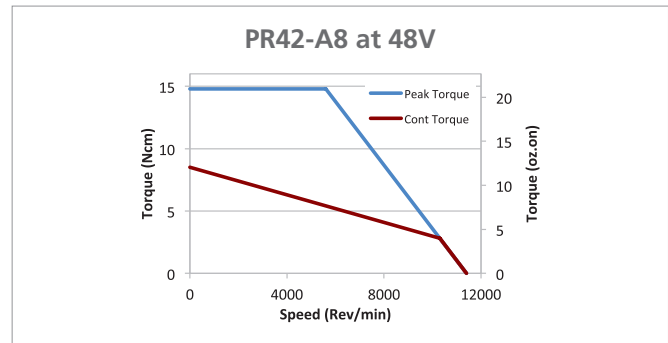
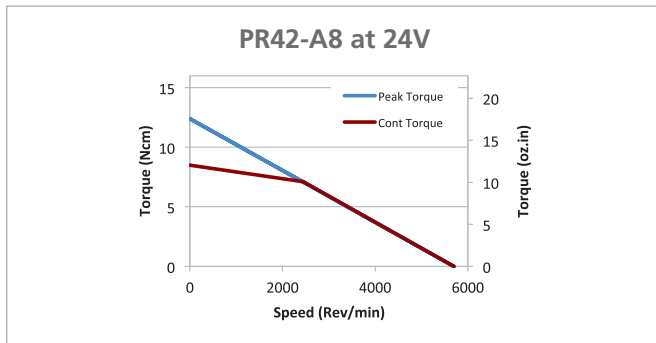

Order part code for the PR42-A16V48A-0-D-CAN

PR	42	-	A	16	V	48	A	-	0	-	D	CAN	See fold-out in back of brochure for more information.
Motor technology	Frame size		Drive type	Continuous torque		Voltage	Drive version		Front shaft		Feedback	Network	

# ElectroCraft PRO Series Integrated Motor Drive Controller

## PR60: Brushless DC IMDC



The ElectroCraft PR60 integrated motor drive controllers are the highest-performance products in the range. Each combines a high-performance neodymium brushless motor with a fully programmable controller to give high levels of control in a compact package. The PR60 is available in four frame sizes, providing peak torque of up to 89 Ncm (123 oz-in) and speeds of over 9,000 RPM.

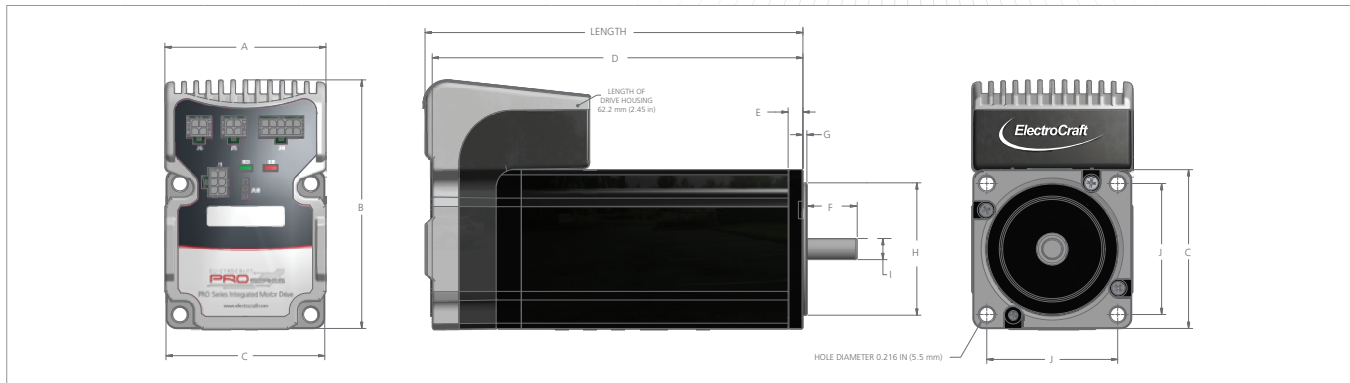
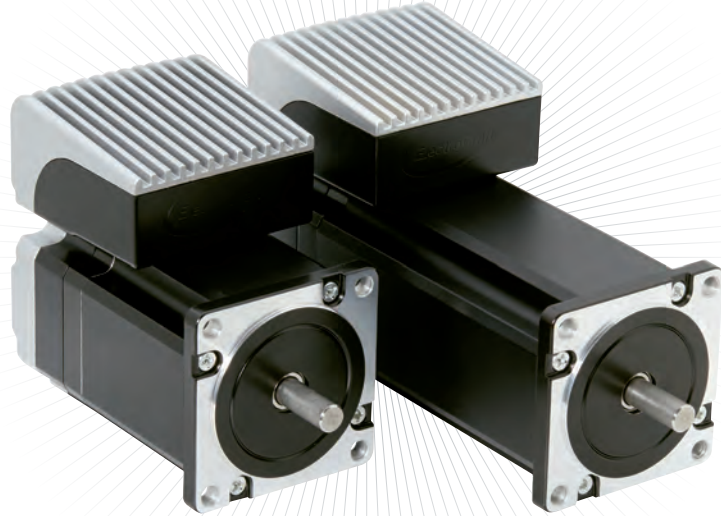

Model	Units	Length	A	B	C	D	E	F	G	H	I	J
PR60-A18	mm	82	60.86	93.94	60	79.2	5.59	20.5±0.76	1.5	49.95 - 50	7.98 - 7.99	49.5
	inch	3.23	2.4	3.7	2.36	3.12	0.22	0.81±0.03	0.059	1.967 - 1.969	0.314 - 0.3145	1.95
PR60-A25	mm	92	60.86	93.94	60	89.25	5.59	20.5±0.76	1.5	49.95 - 50	7.98 - 7.99	49.5
	inch	3.6	2.4	3.7	2.36	3.51	0.22	0.81±0.03	0.059	1.967 - 1.969	0.314 - 0.3145	1.95
PR60-A38	mm	117.3	60.86	93.94	60	114.8	5.59	20.5±0.76	1.5	49.95 - 50	7.98 - 7.99	49.5
	inch	4.62	2.4	3.7	2.36	4.52	0.22	0.81±0.03	0.059	1.967 - 1.969	0.314 - 0.3145	1.95
PR60-A52	mm	143	60.86	93.94	60	140.06	5.59	20.5±0.76	1.5	49.95 - 50	7.98 - 7.99	49.5
	inch	5.6	2.4	3.7	2.36	5.51	0.22	0.81±0.03	0.059	1.967 - 1.969	0.314 - 0.3145	1.95

## Parameter

Motor designation	PR60-A18	PR60-A25	PR60-A38	PR60-A52	Motor designation	PR60-A18	PR60-A25	PR60-A38	PR60-A52
Rated input voltage VDC	12 – 48				Rotor Inertia Kg.cm <sup>2</sup> (oz-in sec <sup>2</sup> )	0.106 (0.0015)	0.205 (0.0029)	0.332 (0.0047)	0.509 (0.0072)
Frame length mm (in)	82 (3.2)	92 (3.6)	117 (4.6)	143 (5.6)	No Load Speed Rev/min	8,000	9,460	4,800	3,980
Encoder lines/rev	1000, 2000, 5000				Phase Resistance Ohm	3.6	1.3	1.6	1.3
Continuous Torque Ncm (oz-in)	18 (25.5)	25 (35.4)	38 (53.8)	52 (73.6)	Phase Inductance mH	4.6	1.8	2.4	2.0
Peak Torque Ncm (oz-in)	35 (49.6)	56.5 (80.0)	80 (113)	89 (126)	Torque Constant Ncm/A (oz-in/A)	6.4	5.3	9.5	10.7
*Motor weight Kg (oz)	0.62 (22)	0.88 (31)	1.2 (42)	1.5 (53)	Voltage Constant V/kRPM	6.7	5.5	10.0	11.2

\*Typical weight. May vary with options selected.

Rated operating temperature 40°C



## Torque/speed curves

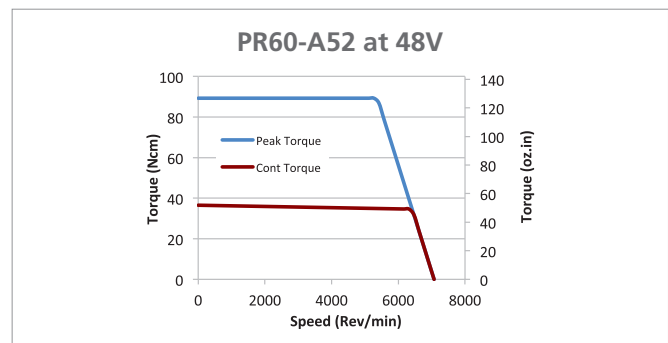
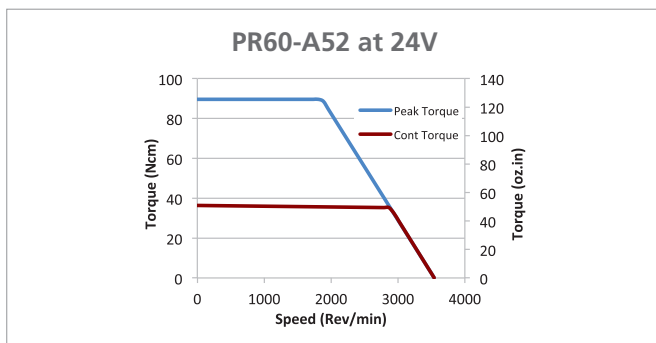
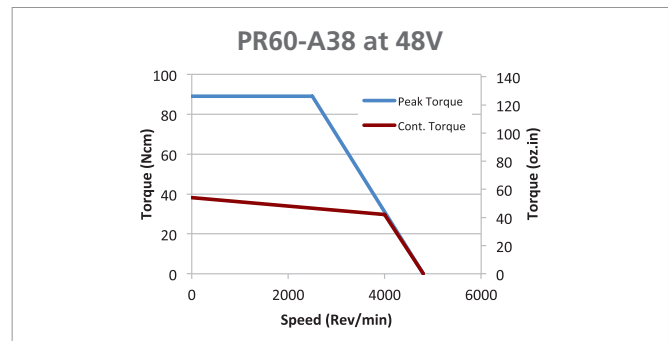
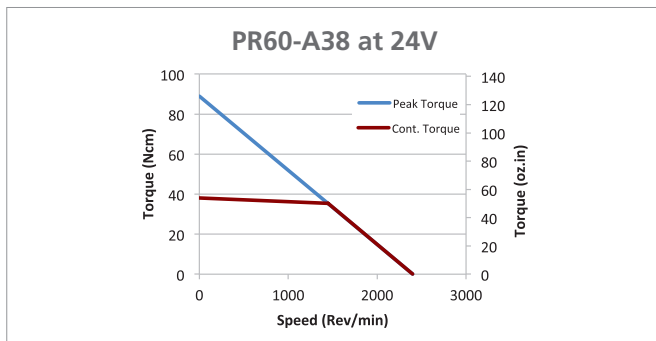
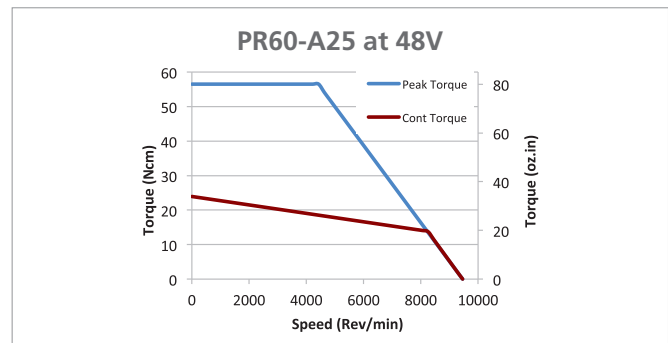
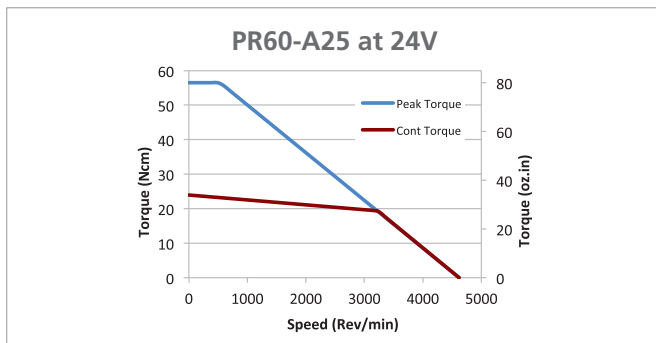
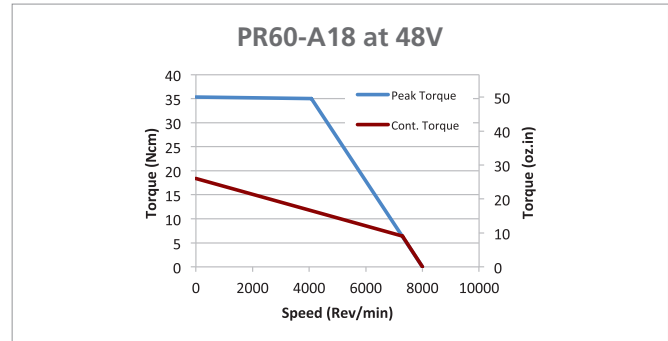
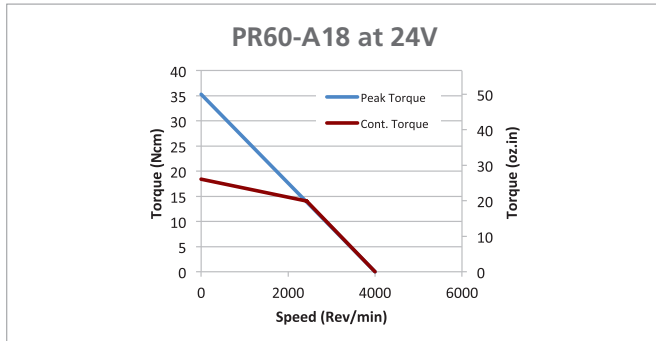

Order part code for the PR60-A25V48A-0-D-CAN

PR	60	-	A	25	V	48	A	-	0	-	D	CAN	See fold-out in back of brochure for more information.
Motor technology	Frame size		Drive type	Continuous torque		Voltage	Drive version		Front shaft		Feedback	Network	

# ElectroCraft PRO Series Integrated Motor Drive Controller

## PS42: Stepper Actuator IMDC



The ElectroCraft PS42 IMDC Stepper Actuator is linear motion in its most compact form, enabling users to reduce installation costs and machine footprint by installing simpler control and cabling architectures. It is available in two forms, as a linear actuator or a leadscrew motor. The integrated PRO Series drive makes the PS42 highly configurable, incorporating the full range of sequence control, I/O and communication options. Versions with ballscrews and special material parts are available for custom application-specific designs – contact ElectroCraft for more information. The PS42 is available with a range of 1/4 inch standard threads, providing resolutions of up to .00031 in (.00787 mm) in full step open-loop mode. Higher resolutions are available in micro-stepping and closed-loop position control mode.

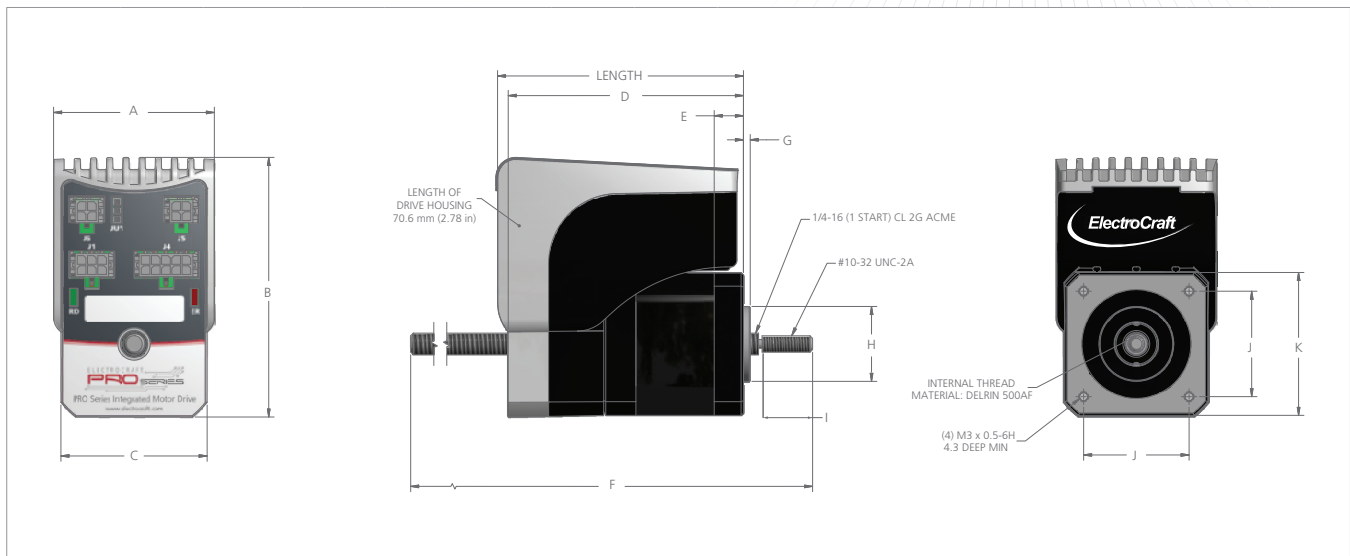
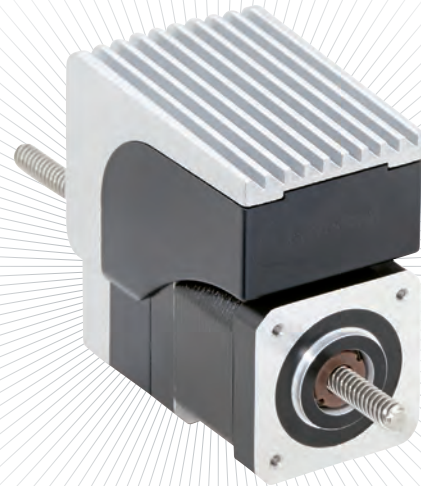

Model	Units	Length	A	B	C	D	E	F	G	H	I	J	K
PS42-A44	mm	72.27	47.24	76.3	1.69	69.12	8.6	152.4±0.8	2.0	21.97-22	12.75	31.0	42.01
	inch	2.85	1.86	3.0	42.96	2.72	0.34	6.0±0.03	0.08	0.865-0	0.5	1.22	1.65

### Parameter

Motor designation	PS42-A44	No Load Speed @ 24V RPM	1050
Rated input voltage VDC	12 – 48	No Load Speed @ 48V RPM	2100
Frame length mm (in)	72 (2.85)	Rotor Inertia Kg.cm <sup>2</sup> (oz-in sec <sup>2</sup> )	0.064 (0.00091)
Step Angle °/step	1.8	Phase Resistance Ohm	1.25
Holding Torque Ncm (oz-in)	44 (62)	Phase Inductance mH	2.32
Weight* Kg (oz)	0.47 (16.6)	*Typical weight. May vary with options selected. Rated operating temperature 40°C	

## Force/speed curves

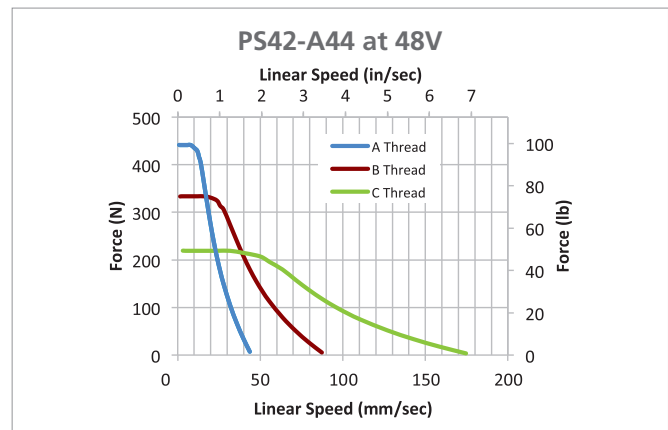
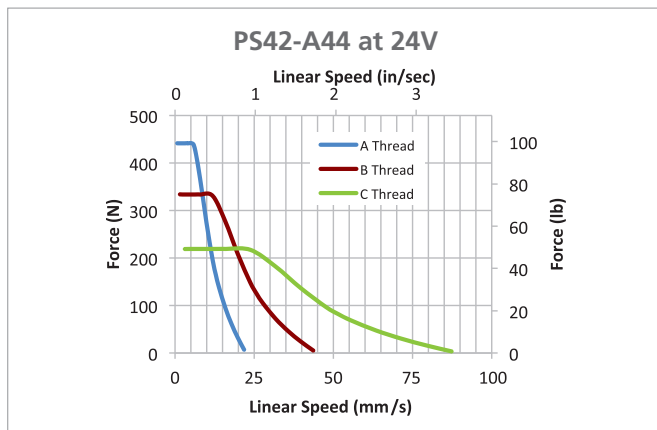

The linear motion characteristics of the actuator can be calculated using the Pitch of the thread and its number of starts. The linear distance the actuator moves for each revolution of the motor is known as the Lead.

$$\text{Lead} = \text{Pitch} \times \text{number of starts.}$$

Thus a 1/4 - 16 ACME (2S) ACME thread will have a diameter of 1/4 inch, a Pitch of 1/16 of an inch and two

starts, giving a lead of 1/8 inch. The motion of stepper motors is sometimes described in terms of their step count. ElectroCraft Integrated Stepper Actuators have a step count of 200 per revolution. In this instance, the Lead is equivalent to 200 steps. So for a 1/4 - 16 (2S) ACME thread, 200 steps will be equivalent to 1/8 inch of linear motion.

## Thread options for the PS42

Thread	Description	Starts	Diameter (in)	Pitch (in)	Lead (in)	Resolution at 200 steps/rev (in)
A	1/4 - 16 ACME (1S)	1	1/4	1/16	1/16	0.00031
B	1/4 - 16 ACME (2S)	2	1/4	1/16	1/8	0.00063
C	1/4 - 16 ACME (4S)	4	1/4	1/16	1/4	0.00125
*E	1/4 - 20 ACME (1S)	1	1/4	1/20	1/20	0.00025
*F	1/4 - 20 ACME (4S)	4	1/4	1/20	1/5	0.001
*J	1/4 - 40 UNI (1S)	1	1/4	1/40	1/40	0.000125
*V	1/4 - 32 ACME (1S)	1	1/4	1/32	1/32	0.000156

\* These threads available on request. More information on threads can be found on Page 24.

## Order part code for the PS42-A44V48A-0AB4-D-CAN

PS	42	-	A	44	V	48	A	-	0	A	B	4	-	D	-	CAN	See fold-out in back of brochure for more information.
Motor technology	Frame size	Drive type	Holding torque	Voltage	Drive version	Linear actuator	Thread	Screw length	End mod	Feedback	Network						

# ElectroCraft PRO Series Integrated Motor Drive Controller

## PS56: Stepper Actuator IMDC



The PS56 is the larger frame size variant of the ElectroCraft integrated Stepper Actuator IMDC and is available as a linear actuator or lead screw motor. The integrated PRO Series drive makes the PS56 highly configurable, incorporating the full range of sequence control, I/O and communications options. This makes it ideal for incorporation into centralized or distributed architectures where controlled high-power force is needed. Special versions with ballscrews and special material parts are available for custom application-specific designs – contact ElectroCraft for more information. The PS56 is available with a range of 3/8 inch standard threads, providing resolutions of up to .00025 in (.00635 mm) in full step open-loop mode. Even higher resolutions are available in micro-stepping and closed-loop position control mode.

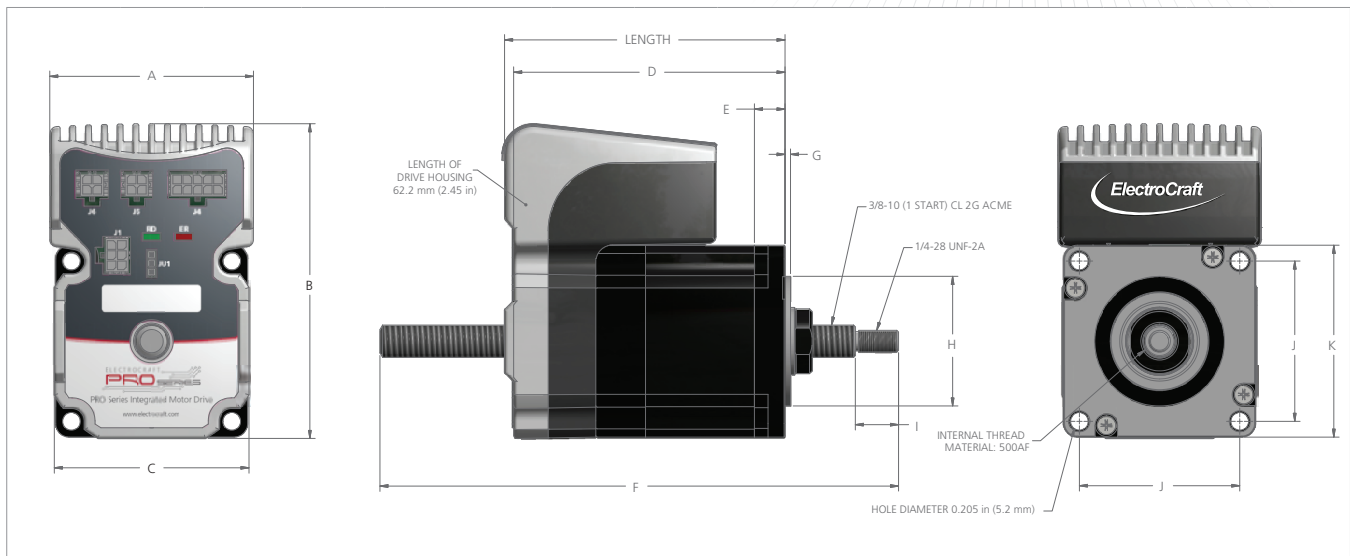

Model	Units	Length	A	B	C	D	E	F	G	H	I	J	K
PS56-A64	mm	71	59.86	92.51	57.21	79.75	9.0	152.4±0.76	1.6	38.1±0.05	12.7	47.1	56.4
	inch	2.8	2.36	3.64	2.25	3.14	0.35	6±0.03	0.06	1.5±0.002	0.5	1.85	2.22
PS56-A106	mm	82	59.86	92.51	57.21	79.75	9.0	152.4±0.76	1.6	38.1±0.05	12.7	47.1	56.4
	inch	3.2	2.36	3.64	2.25	3.14	0.35	6±0.03	0.06	1.5±0.002	0.5	1.85	2.22

### Parameter

Motor designation	PS56-A64	PS56-A106	Motor designation	PS56-A64	PS56-A106
Rated input voltage VDC	12 – 48		No Load Speed @ 24V RPM	1100	975
Frame length mm (in)	71 (2.8)	82 (3.2)	No Load Speed @ 48V RPM	2250	2100
Step Angle °/step	1.8	1.8	Rotor Inertia Kg.cm <sup>2</sup> (oz-in sec <sup>2</sup> )	0.155 (0.0022)	0.26 (0.0037)
Holding Torque Ncm (oz-in)	64 (90)	106 (130)	Phase Resistance Ohm	0.6	0.8
Weight* Kg (oz)	0.69 (24)	0.9 (31.4)	Phase Inductance mH	2.0	3.5

\*Typical weight. May vary with options selected.

Rated operating temperature 40°C

## Force/speed curves

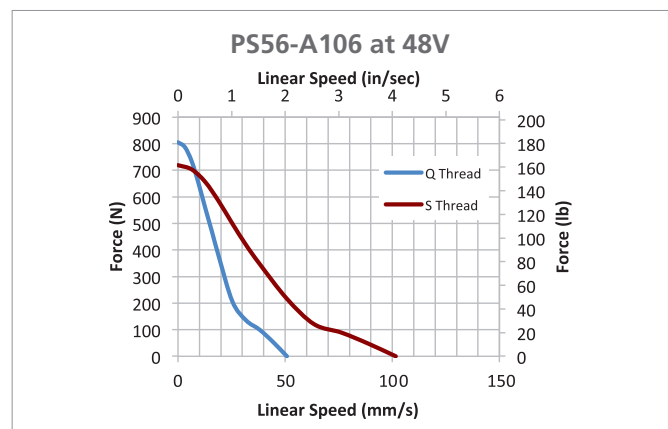
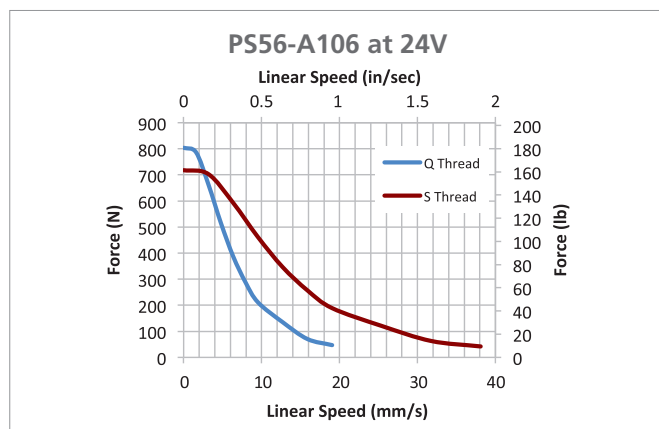
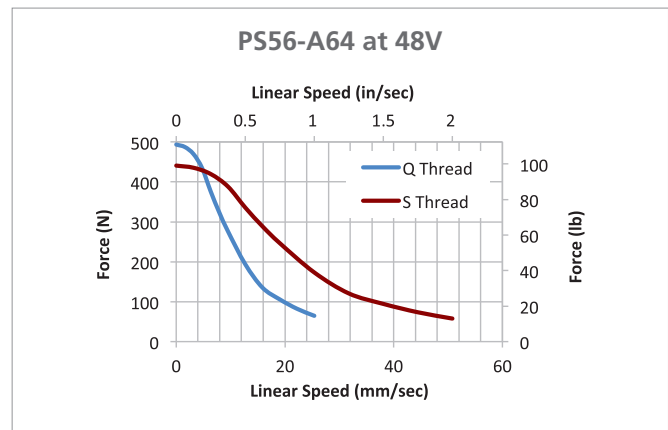
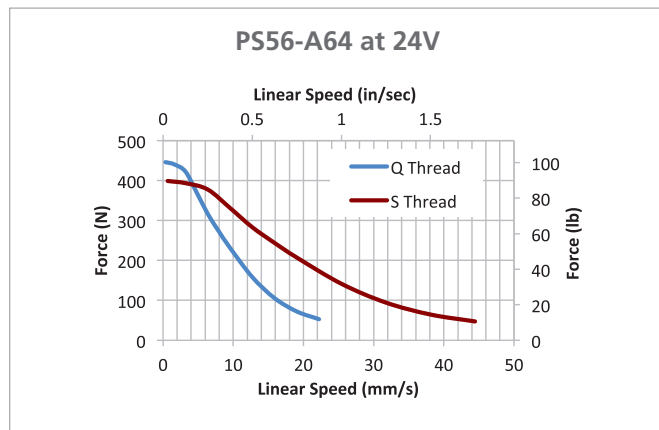

The linear motion characteristics of the actuator can be calculated using the Pitch of the thread and its number of starts. The linear distance the actuator moves for each revolution of the motor is known as the Lead.

$$\text{Lead} = \text{Pitch} \times \text{number of starts.}$$

Thus a 3/8 - 12 ACME (2S) thread will have a diameter of 3/8 of an inch, a Pitch of 1/12 of an inch and two starts, giving a lead of 1/6 inch. The motion of stepper motors is sometimes described in terms of their step count. ElectroCraft Integrated Stepper Actuators have a step count of 200 per revolution. In this instance, the Lead

is equivalent to 200 steps. So for a 3/8 - 12 ACME (2S) thread, 200 steps will be equivalent to 1/6 of an inch of linear motion.

### Thread options for the PS56

Thread	Description	Starts	Diameter (in)	Pitch (in)	Lead (in)	Resolution at 200 steps/rev (in)
*L	3/8 - 12 ACME (2S)	2	3/8	1/12	1/16	0.00083
Q	3/8 - 20 ACME (1S)	1	3/8	1/20	1/20	0.00025
S	3/8 - 10 ACME (1S)	1	3/8	1/10	1/10	0.0005
*T	3/8 - 10 ACME (1S)	1	3/8	1/16	1/16	0.0003
*W	3/8 - 12 ACME (1S)	1	3/8	1/12	1/12	0.00042

\* These threads available on request.  
More information on threads can be found on Page 24.

### Order part code for the PS56-A106V48A-0SB7-D-CAN

PS	56	-	A	106	V	48	A	-	0	S	B	7	-	D	-	CAN	See fold-out in back of brochure for more information.
Motor technology	Frame size	Drive type	Holding torque	Voltage	Drive version	Linear actuator	Thread	Screw length	End mod	Feedback	Network						



## Product Range of ElectroCraft



ElectroCraft  
CompletePower™  
Drives

With meticulous engineering and advanced electronics, our CompletePower speed controls and servo drives offer reliability and precision servo motion control. From sensitive medical dosing systems to rugged professional power tools, our CompletePower devices can handle a wide variety of applications.



ElectroCraft  
RapidPower™  
BLDC

Our BLDC motors provide the rapid acceleration and consistent speed needed for applications from centrifuges to x-y positioning systems. The RapidPower product line ensures a steady operation at any speed by utilizing sealed ball bearings and reduced torque ripple from skewed magnetization.



ElectroCraft  
PRO Series  
Drives

The PRO Series Programmable Servo Drive provides a new design concept offering a cost effective, compact and modular solution for the control of rotary or linear stepper, brushless or PMDC brush motors of powers up to 385W, with up to 48V nominal voltage and 5.7A (RMS) continuous current.



ElectroCraft  
**TorquePower™**  
Steppers

With non-cumulative position accuracies as low as  $\pm 3\%$ , the precision of our TorquePower motor is matched only by the dependability of its performance. Bi-directional operation and enclosed, permanently lubricated ball bearings provide long-lasting, smooth operation.

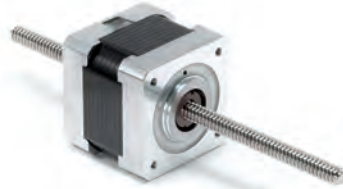

ElectroCraft  
**AxialPower™**  
Linear Actuator

Based on modified hybrid steppers, PMDC and BLDC motors, our family of AxialPower linear actuators are built to last. Our unique approach to linear motion with low-friction, polymer rotating nuts and stainless steel leadscrews provides high force and linear precision in the smallest packages available.



ElectroCraft  
**DirectPower™**  
PMDC

Dynamically balanced armatures and precision ball bearings ensure that the DirectPower line maintains its characteristically smooth performance. This durable, totally enclosed, non-ventilated (TENV) motor is available in a broad product line from lower cost, general purpose options to high performance PMDC servo motors.



ElectroCraft  
**MobilePower™**  
Transmissions

With a choice of output ratios, our MobilePower line of products helps power battery-operated vehicles from wheelchairs to lift trucks. And, to increase durability and decrease noise levels, the robust all metallic gears are hobbled to a precision AGMA 9-Class.



ElectroCraft  
**SolidPower™ Plus**  
Housed AC

High starting torques and stator windings matched to your application ensure the SolidPower product provides lasting performance. The dynamically balanced, skewed rotor bars and precision-machined fits keep vibration levels at a minimum.



ElectroCraft  
**SurePower™**  
C-Frame AC

Our AC shaded-pole motor, the SurePower product, can be utilized for a wide range of air-moving applications – perfect for the rigors of refrigeration and commercial food equipment applications.

# ElectroCraft PRO Series Integrated Motor Drive Controller

## Family Part Number Configurator

### Rotary

A	Advanced	44	PT42	64	PT56	8	PR42	18	PR60	48	A	
Drive Type		55		106		16		25		Voltage		
				170		25		38		Drive Version		
		Torque (Ncm)						52				

P	T	42	-	A	55	V	48	A	-	0	-	D	-	CAN
---	---	----	---	---	----	---	----	---	---	---	---	---	---	-----

Type	Motor Technology	Frame Size (mm)	Front Shaft	Feedback	Network
P	T	42	0	X	CAN
Pro Series	Stepper	Stepper	Round, metric	None	
	R	56	1	D	CAT
	Brushless	Brushless	Flat, metric	1000	
		42	2	L	
		60	Round, NEMA	2000	
			3	M	
			Flat, NEMA	5000*	

\*5000 line encoder speed limited to 8500RPM

### Linear

0	Linear actuator - Regular	A	1/4-16 ACME (15)	X	None	0	No End Mod	X	None	CAN
1	Leadscrew Motor	B	1/4-16 ACME (25)	A	3"	1	6-32 UNC	D	1000	CAT
Product		C	1/4-16 ACME (45)	B	6"	2	M2.5 X 0.45	L	2000	
		E	1/4-20 ACME (15)	C	12"	3	0.098/0.097 Dia [2.5mm]	M	5000*	
		F	1/4-20 ACME (45)	D	18"	4	10-32 UNF	Feedback		Network
		J	1/4-40 UN (15)	E	24"	5	M5 X 0.8			
		L	3/8-12 ACME (25)	Screw Length		6	0.196/0.195 Dia [5mm]			
		Q	3/8-20 ACME (15)			7	1/4-28 UNF			
		S	3/8-10 ACME (15)			8	M6 X 1.0			
		T	3/8-16 ACME (15)			9	0.235/0.236 Dia [6mm]			
		W	3/8-12 ACME (15)			End Mod				
		V	1/4-32 ACME (15)							

P	S	42	-	A	44	V	48	A	-	0	A	B	4	-	X	-	CAN
---	---	----	---	---	----	---	----	---	---	---	---	---	---	---	---	---	-----

Type	Motor Technology	Frame Size (mm)	Drive Type	Torque (Ncm)	Voltage	Drive Version
P	S	42	A	44	48	A
Pro Series	Stepper	Stepper	Advanced	PS42		
		56		64		
				106		
				PS56		



## ElectroCraft PRO Series Integrated Motor Drive Controller

### Accessories

#### Evaluation Kit



PN	Description
2000710	PT42-A55V48A-0-X-CAN Open-loop Stepper
2000711	PT42-A55V48A-0-D-CAN Closed-loop Stepper
2000752	PT56-A106V48A-0-X-CAN Open-loop Stepper
2000753	PT56-A106V48A-0-D-CAN Closed-loop Stepper
2000712	PR42-A16V48A-0-D-CAN Closed-loop Brushless
2000713	PR42-A32V48A-0-D-CAN Closed-loop Brushless
2000754	PR60-A25V48A-0-D-CAN Closed-loop Brushless
2000755	PR60-A52V48A-0-D-CAN Closed-loop Brushless
2000714	PS42-A44V48A-0AB4-X-CAN Open-loop Integrated Stepper Linear Actuator
2000715	PS42-A44V48A-0AB4-D-CAN Closed-loop Integrated Stepper Linear Actuator
2000756	PS56-A106V48A-0SB7-X-CAN Open-loop Integrated Stepper Linear Actuator
2000757	PS56-A106V48A-0SB7-D-CAN Closed-loop Integrated Stepper Linear Actuator

#### Mating Cable

PN	Description	Length meter
1001359	<b>PRO Series IMDC Interface Cable Kit:</b>	
	PRO Series IMDC Power Connector (J1) to Flying Lead	3
	PRO Series IMDC I/O Connector (J4) to Flying Lead	3
1001360	<b>PRO Series IMDC Power &amp; I/O Cable Kit:</b>	
	PRO Series IMDC Power Connector (J1) to Flying Lead	3
	PRO Series IMDC I/O Connector (J4) to Flying Lead	3



#### Miscellaneous Accessories

PN	Description
2000685	CompletePower Braking Module With External Bus Capacitance (13W, 4.7 Ohm)

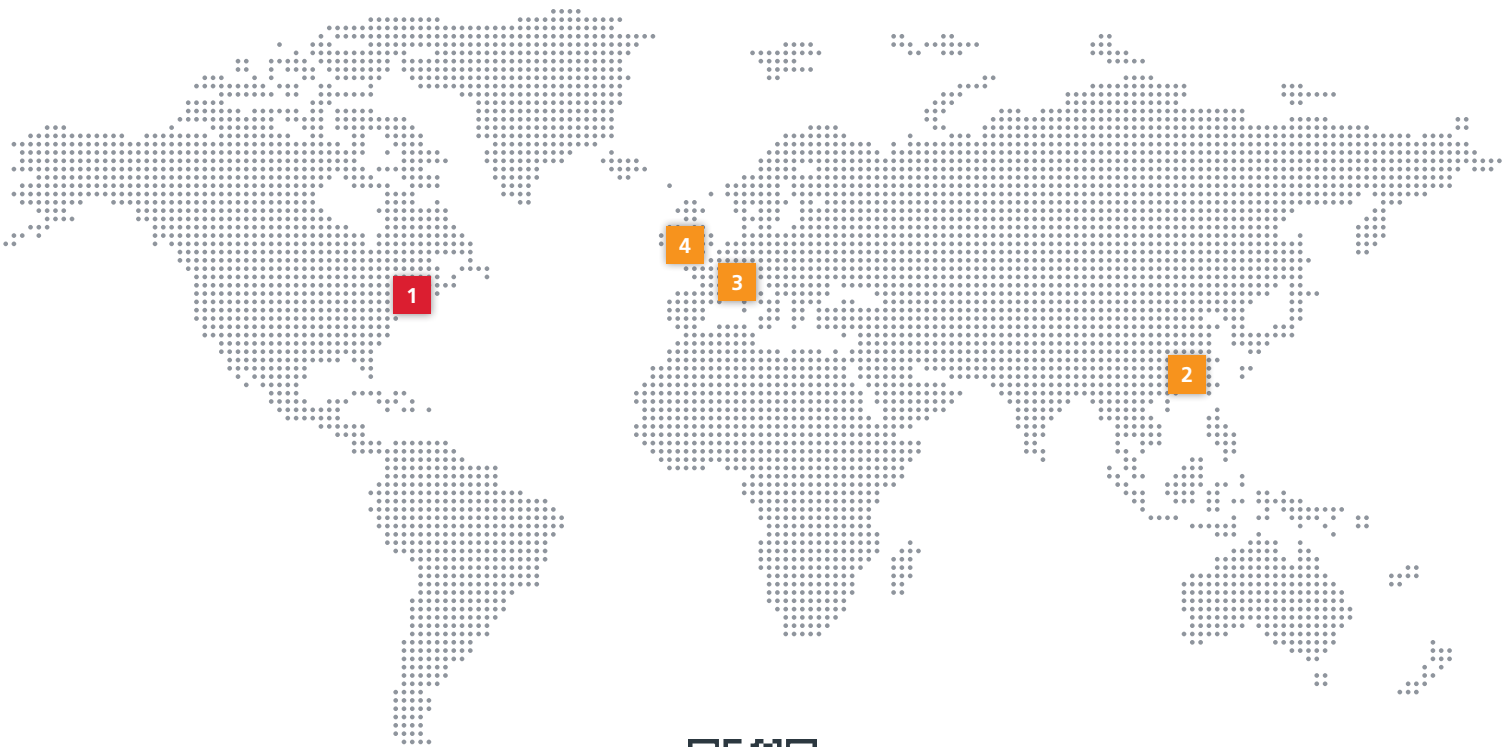

www.electrocraft.com

## Headquarters, USA 1

1 Progress Drive | Dover | New Hampshire | 03820  
Telephone: +1 603 516 1200 | Fax: +1 603 742 9080

### Sales & Applications Engineering

#### USA

1 Progress Drive, Dover,  
New Hampshire, 03820  
Tel: +1 603 516 1200  
Fax: +1 603 742 9080

1

#### Hong Kong (Asia Pacific)

Rm 1118, Delta House 3  
On Yiu Street | Shatin, NT.  
Tel: +852 316 3225 0  
Fax: +852 316 3225 1

2

#### Germany

Seelbergstraße 9  
D-70372 Stuttgart  
Tel: +49(0) 711 7272 05 0  
Fax: +49(0) 711 7272 05 44

3

#### UK (EMEA)

Unit 4, Crewe Trade Park  
Crewe, Cheshire, CW1 6JT, UK  
Tel: +44(0) 127 0580 14 2  
Fax: +44(0) 127 0251 24 0

4